

Dongguan Merrock Industry Co.,Ltd

311 Room , Technology Communication Building, Wanjiang District , Dongguan City , GuangDong Province , China

Contactor: Lucy Luo Tel: 86-769-23291955 Fax: 86-769-23152826 Mobile:86-13217696818

E-Mail: dgmerrock@hotmail.com Web: <http://www.stonefloorpolisher.com/>

S-X₁₂-650 GRINDER

Operating Manual



☑ S-X₁₂-650

Dongguan Merrock Industry Co.,Ltd

311 Room , Technology Communication Building, Wanjiang District , Dongguan City , GuangDong Province , China

Contactor: Lucy Luo Tel: 86-769-23291955 Fax: 86-769-23152826 Mobile:86-13217696818

E-Mail: dgmerrock@hotmail.com Web: <http://www.stonefloorpolisher.com/>

S-X₁₂-650 GRINDER Operating Manual

This book has important information for use and safe operation of this machine. Failure to read this book prior to operating or attempting any service or maintenance procedure to your concrete Grinder could result in injury to you or other personnel, damage to the machine or to other property could occur as well. You must have training in the operation of this machine before using it.

Model Specifications

Description.....	S-X ₁₂ -650 Grinder
Voltage.....	220V
Working Width.....	Φ650MM /25 IN
Rotation Speed (rpm).....	300-1200
Transmission.....	Gear
Power (hp).....	10
Power Cord (mt).....	10 M / 33 FT
Water Tank.....	30L/ 8 Gal
Weight.....	310 kg (683.43 lbs)
Disc Quantity.....	12
Inverter.....	yes

Machine Instructions

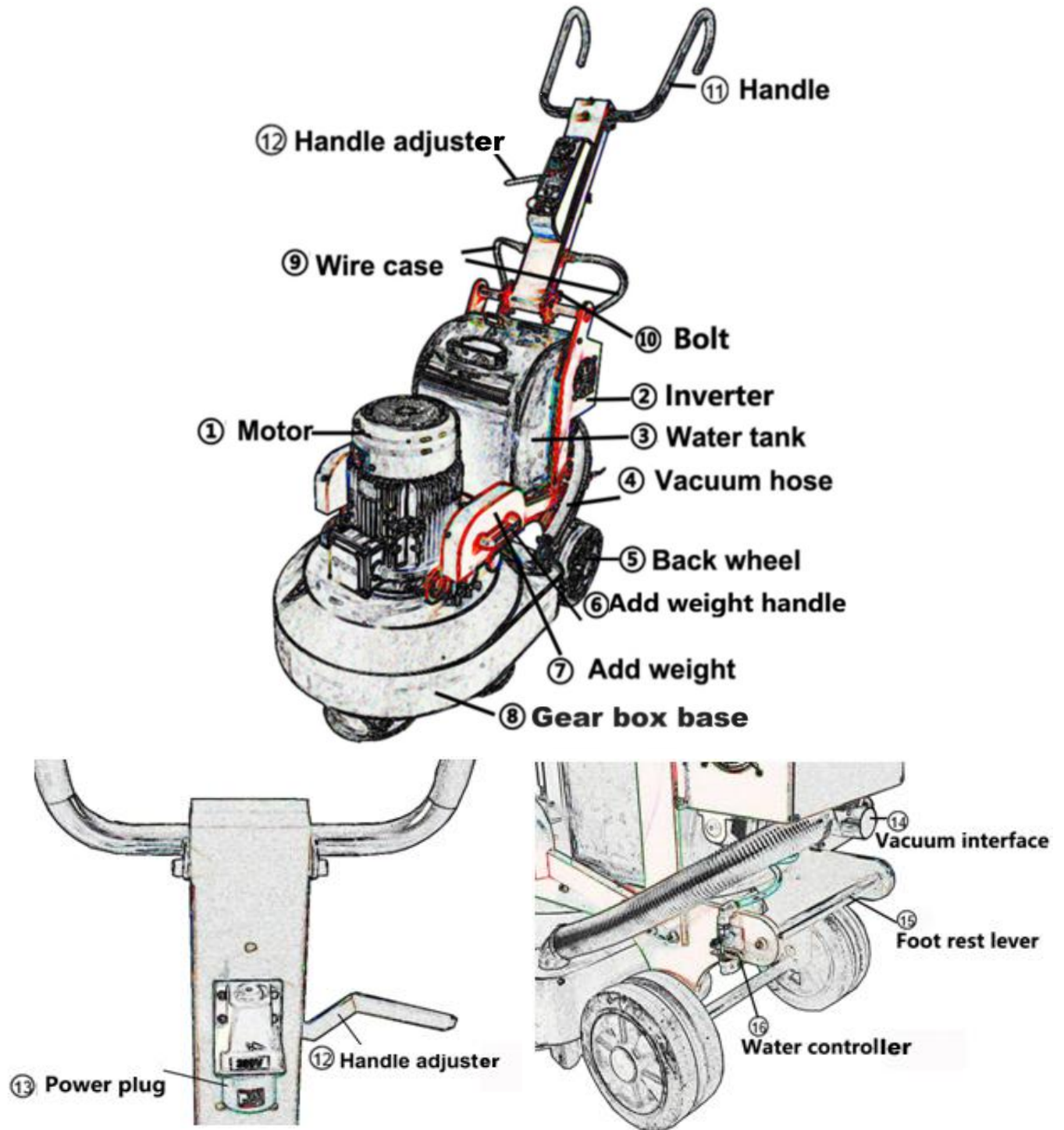

Dongguan Merrock Industry Co.,Ltd

311 Room , Technology Communication Building, Wanjiang District , Dongguan City , Guangdong Province , China

Contactor: Lucy Luo Tel: 86-769-23291955 Fax: 86-769-23152826 Mobile:86-13217696818

E-Mail: dgmerrock@hotmail.com Web: <http://www.stonefloorpolisher.com/>

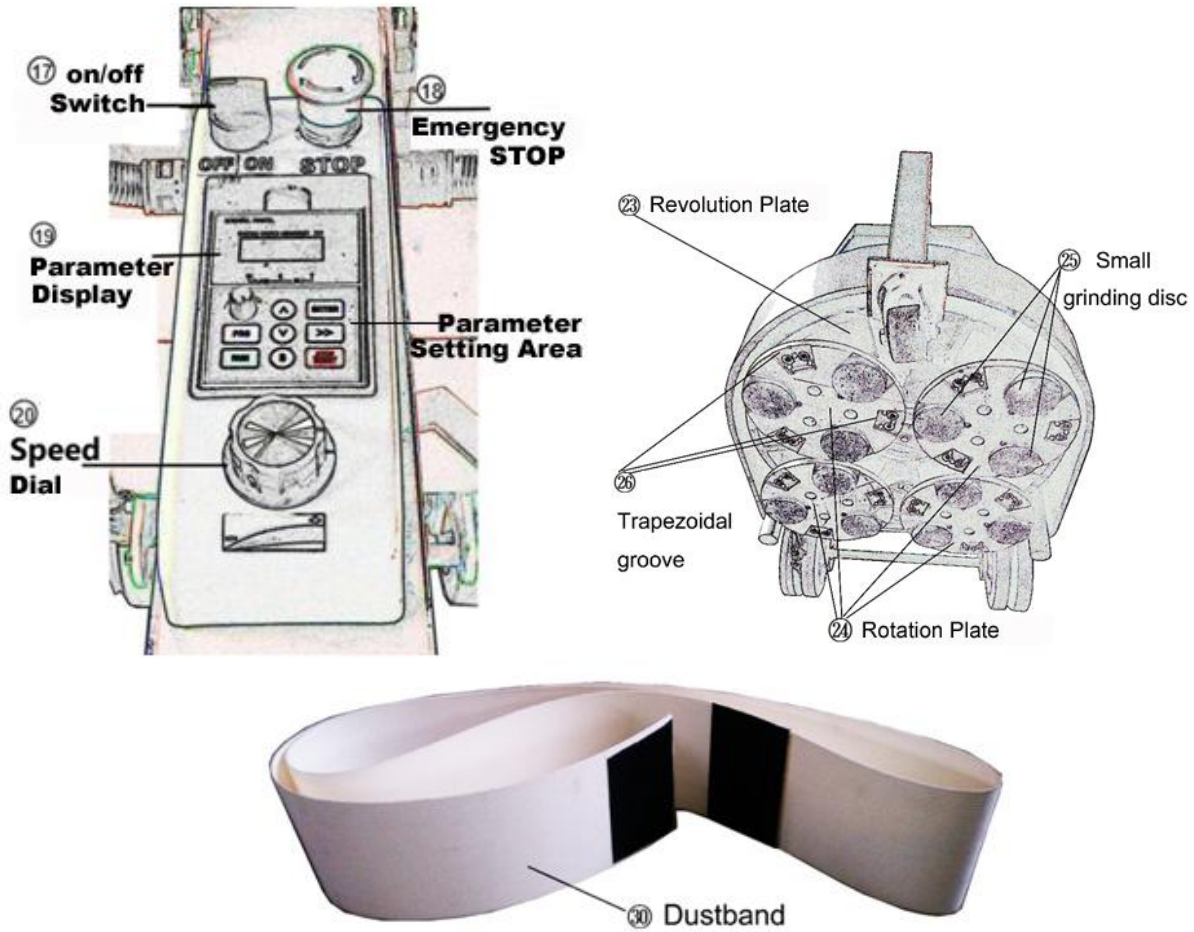

Attaching Diamond/Resin Tooling

Moving the machine

Insert lever sheath, adjust handle to horizontal position, and lift machine.

Changing/Attaching tooling

Tip over the machine as shown in pictures below



Put both add weight irons to back

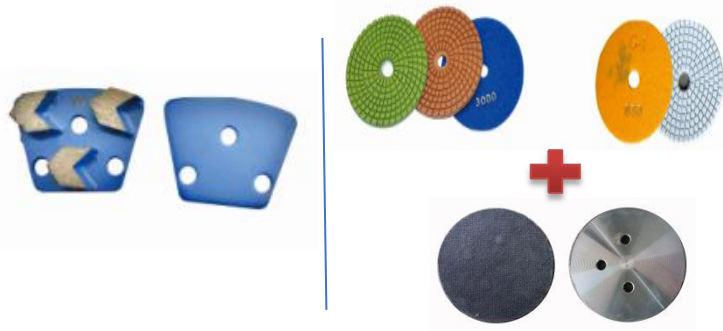

Dongguan Merrock Industry Co.,Ltd

311 Room , Technology Communication Building, Wanjiang District , Dongguan City , GuangDong Province , China
 Contactor: Lucy Luo Tel: 86-769-23291955 Fax: 86-769-23152826 Mobile:86-13217696818
 E-Mail: dgmerrock@hotmail.com Web: <http://www.stonefloorpolisher.com/>

Inverter Programming

AC70 Veichi Frequency Inverter

The standard Inverter is installed with LED display panel, as shown in Figure below

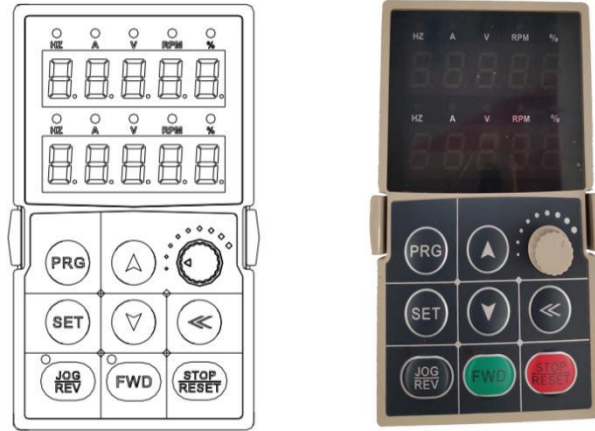

Key	Name	Function
	Menu key	Entry or exit programming key
	Confirm/modify key	Confirm saving the data or modify the date
	Up/down key	Increase /Decrease value or parameter
	Shift key	Selecting display parameter and shift
	Forward run key	While run/stop is controlled by keyboard, press this key, the inverter forward rotate and the indicator is always on. While reverse, the indicator sparks.
	Jog/reverse key	In the mode of display panel control, jog start the Inverter
	Stop/reset key	In the mode of display panel control, to stop the Inverter and reset fault
	Keyboard potentiometer	Can be used as input channel for given frequency, upper frequency limit, given torque, given PID or PID feedback setting.

Dongguan Merrock Industry Co.,Ltd

311 Room , Technology Communication Building, Wanjiang District , Dongguan City , Guangdong Province , China

Contactor: Lucy Luo Tel: 86-769-23291955 Fax: 86-769-23152826 Mobile:86-13217696818

E-Mail: dgmerrock@hotmail.com Web: <http://www.stonefloorpolisher.com/>

Trouble Shooting

Scratch on Floor

1. Machine standing still while running
2. Grinding method is not correct
3. Using incorrect pads
4. Incorrect operation

Machine wobbles during operation

1. Check ground level for level difference.
 - a. If level difference is serious (2mm above), first repair with the angle grinder machine
 - b. Then, grind slowly from higher level to lower level with constant speed and shape moving
2. Make sure pad holders are tight
3. Make sure all pads are the same
4. Make sure pads are on same level
5. Adjust connector between machine frame and machine base, keep the pad holders and wheels in the same level

Machine suddenly STOPS running (Over current protection)

1. Tap the STOP button, then after 5 seconds tap the RUN button to restart. Gently press the handle when restarting to make sure pad holder has small friction which will restart easier.

Machine will not run

1. Check plug for proper connection-on machine AND at wall outlet
2. Check building circuit breaker
3. Look at the Inverter parameters and debug according to the “ERR” instructions below.

ERR 1 Open-phase at input side Open-phase infrequency inverter three phase input power phase
Check three phase input power and wiring

ERR 2 Output grounding Frequency inverter has device grounding short circuit at the outputside
Check peripheral device, grounding line, motor insulation

ERR 6 Keyboard communication fault 1-Keyboard wiring fault
2-Keyboard communication component damaged

Check the Keyboard wiring, Ask for technical support

Dongguan Merrock Industry Co.,Ltd









311 Room , Technology Communication Building, Wanjiang District , Dongguan City , GuangDong Province , China

Contactor: Lucy Luo Tel: 86-769-23291955 Fax: 86-769-23152826 Mobile:86-13217696818

E-Mail: dgmerrock@hotmail.com Web: <http://www.stonefloorpolisher.com/>

Fault Diagnoses and Processing

Fault Information and Details











Keyboard display	Fault code	Fault type	Possible causes	Treatment
	L.U1	Too low voltage while stop	<ul style="list-style-type: none"> ● Power supply is too low ● Voltage detection circuit is abnormal 	<ul style="list-style-type: none"> ● Check input power,clear fault. ● Seek support from factory.
	E.LU2	Too low voltage in run	<ul style="list-style-type: none"> ● Power supply is too low ● Power capacitance is too small, or there is big impact current in the power grid. ● Inner DC main contactor is not connect well 	<ul style="list-style-type: none"> ● Check input power,clear fault. ● Improve powersupply. ● Seek support from factory.
	E.oU1	Accel. over-voltage	<ul style="list-style-type: none"> ● Power voltage fluctuation over limit. ● Start when motor is running . 	<ul style="list-style-type: none"> ● Detect power voltage and clear fault. ● Restart motor until it completely stop.Set E-30 as 1or2.
	E.oU2	Decel. over-voltage	<ul style="list-style-type: none"> ● Deceleration time is too short. ● Load potential energy or inertia is too large. ● Power voltage fluctuation over limit. 	<ul style="list-style-type: none"> ● Prolong Deceleration time. ● Reduce load inertia or improve inverter capacitance or add braking unit. ● Detect power voltage and clear fault.
	E.oU3	Constant speed over-voltage	<ul style="list-style-type: none"> ● Power voltage fluctuation over limit. 	<ul style="list-style-type: none"> ● Detect power voltage and clear fault. ● Install input reactor.
	E.oU4	Over-voltage while stop	<ul style="list-style-type: none"> ● Power voltage fluctuation over limit. 	<ul style="list-style-type: none"> ● Check input power,clear fault. ● Seek support from factory.
	E.oC1	Accel. over-current	<ul style="list-style-type: none"> ● Acceleration time is too short. ● Start running motor. ● V/F curve setting is not suitable.Or torque boost too high. ● Inverter capacitance is too small. 	<ul style="list-style-type: none"> ● Prolong acc time. ● Restart motor until it totally stop.Set E-30 as 1or2. ● Reset V/F curve or torque boost value. ● Select inverter with right capacitance.
	E.oC2	Decel. over-current	<ul style="list-style-type: none"> ● Deceleration time is too short. ● Load potential energy or inertia is too large. ● Power voltage fluctuation over limit. 	<ul style="list-style-type: none"> ● Prolong Deceleration time. ● Connect external braking resistance or braking unit. ● Select inverter with right capacitance.
	E.oC3	Constant speed over-current	<ul style="list-style-type: none"> ● Sudden load change. ● Power grid voltage is too low. 	<ul style="list-style-type: none"> ● Check load change and clear it. ● Check input power,clear fault.

Dongguan Merrock Industry Co.,Ltd

311 Room , Technology Communication Building, Wanjiang District , Dongguan City , GuangDong Province , China

Contactor: Lucy Luo Tel: 86-769-23291955 Fax: 86-769-23152826 Mobile:86-13217696818

E-Mail: dgmerrock@hotmail.com Web: <http://www.stonefloorpolisher.com/>











	E.oL1	Motor over-load	<ul style="list-style-type: none"> ● V/F curve setting is not suitable. Or torque boost too high. ● Power grid voltage is too low. ● incorrect overload protection setting. ● Locked-rotor run or too heavy load. ● Universal motor long time low speed run. 	<ul style="list-style-type: none"> ● Reset V/F curve or torque boost value. ● Check input power,clear fault. ● Unreasonable H-56 setting. ● Adjust load or select inverter with right capacitance. ● If need long time low speed run, please choose special motor for inverter.
	E.oL2	Inverter over-load	<ul style="list-style-type: none"> ● Load is too heavy. ● Acceleration time is too short. ● Start running motor. ● V/F curve setting is not suitable.Or torque boost too high. 	<ul style="list-style-type: none"> ● Select inverter with right capacitance. ● Prolong acceleration time ● Restart motor until it totally stop.Set E-30 as 1or2. ● Reset V/F curve or torque boost value.
	E.SC	System abnormality	<ul style="list-style-type: none"> ● Acceleration time is too short. ● Short circuit between inverter output phases or earth. ● Module is damaged. ● Electromagnetic disturb. 	<ul style="list-style-type: none"> ● Prolong acceleration time. ● Check periphery equipments and restart after fault cleared. ● Seek support from factory. ● Check system wiring, earth, shield and deal as required.
	E.oH	Inverter over-heat	<ul style="list-style-type: none"> ● Temperature is too high. ● Air channel is blocked. ● Fan connection parts is loose. ● Fan is damaged. ● Temperature detection circuit fault 	<ul style="list-style-type: none"> ● Make the environment meeting therequirement. ● Clear the air channel. ● Check and re-connect the wire ● Change the same new fan. ● Seek support from factory.
	E.TE1	Motor static detection fault	<ul style="list-style-type: none"> ● Detection overtime ● Perform static detection while motor is running. ● Capacitance difference is too big between motor and inverter. ● Motor parameter setting mistake. 	<ul style="list-style-type: none"> ● Check motor connection wire. ● Detect after motor stop totally. ● Change inverter model. ● Reset parameter according to nameplate.
	E.TE2	Motor rotation detection fault	<ul style="list-style-type: none"> ● Detect while motor is running. ● Detect with load. ● Detection overtime ● Capacitance difference is too big between motor and inverter. ● Motor parameter setting mistake. 	<ul style="list-style-type: none"> ● Detect after motor stop totally. ● Re-detect without load. ● Check motor connection wire. ● Change inverter model. ● Reset parameter according to nameplate.
	93SE	Memory fault	<ul style="list-style-type: none"> ● Electromagnetic disturb in memory period. ● EEPROM damage. 	<ul style="list-style-type: none"> ● re-input and save. ● Seek support from factory.
	LIFE	Reserved		<ul style="list-style-type: none"> ● Seek support from factory.
	ERR1	Input phase missing	<ul style="list-style-type: none"> ● 3 input phase missing 	<ul style="list-style-type: none"> ● Check 3phase input power and phase. ● Check 3phase input power wiring.
	ERR2	Output phase missing	<ul style="list-style-type: none"> ● 3 phase output of inverter missing connection with motor 	<ul style="list-style-type: none"> ● Check wire between inverter and motor, earth and motor insulation.

Dongguan Merrock Industry Co.,Ltd

311 Room , Technology Communication Building, Wanjiang District , Dongguan City , GuangDong Province , China

Contactor: Lucy Luo Tel: 86-769-23291955 Fax: 86-769-23152826 Mobile:86-13217696818

E-Mail: dgmerrock@hotmail.com Web: <http://www.stonefloorpolisher.com/>

	ERR3	Current detection fault	<ul style="list-style-type: none"> ● Detect circuit fault. ● Phase imbalance 	<ul style="list-style-type: none"> ● Seek for technique support. ● Check motor and wiring.
	ERR4	Inverter external fault	<ul style="list-style-type: none"> ● Peripheral equipment fault protection. 	<ul style="list-style-type: none"> ● Check peripheralequipment.
	ERR5	Swing frequency fault	<ul style="list-style-type: none"> ● User not set right swing frequency running parameter. 	<ul style="list-style-type: none"> ● Set parameter again.
	ERR6	Keyboard connect fault	<ul style="list-style-type: none"> ● Keyboard wire fault. ● Keyboard component damage. 	<ul style="list-style-type: none"> ● Check keyboard wire ● Seek support from factory.
	E.CPE	Parameter copy fault	<ul style="list-style-type: none"> ● Parameter copy communication is fault. ● Copy keyboard is not match the inverter. 	<ul style="list-style-type: none"> ● Check wire. ● Select the specified external keyboard model.
	E.CE	RS485 communication fault	<ul style="list-style-type: none"> ● Baud rate not right. ● Communication connection not right. ● Communication format not right. 	<ul style="list-style-type: none"> ● Set right Baud rate ● Check communication wiring ● Check Communication format
	SEn	Feedback sensor fault	<ul style="list-style-type: none"> ● Alarm while PID analog value feedback signal is small than [H-28]. ● PID feedback wire problem. ● Feedback sensor problem. ● Feedback input circuit problem. 	<ul style="list-style-type: none"> ● Confirm sensor state, change it if problem ● Check wiring. ● Adjust feedback channel signal
	E.PAn	Keyboard connect fault	<ul style="list-style-type: none"> ● Keyboard wire fault. ● Keyboard component damage. 	<ul style="list-style-type: none"> ● Check keyboard wire ● Seek support from factory.
	E.EF	Inverter external fault	<ul style="list-style-type: none"> ● Peripheral equipment fault protection. 	<ul style="list-style-type: none"> ● Check peripheralequipment.
	E.PAn	Keyboard connect fault	<ul style="list-style-type: none"> ● Keyboard wire fault. ● Keyboard component damage. 	<ul style="list-style-type: none"> ● Check keyboard wire ● Seek support from factory.

